

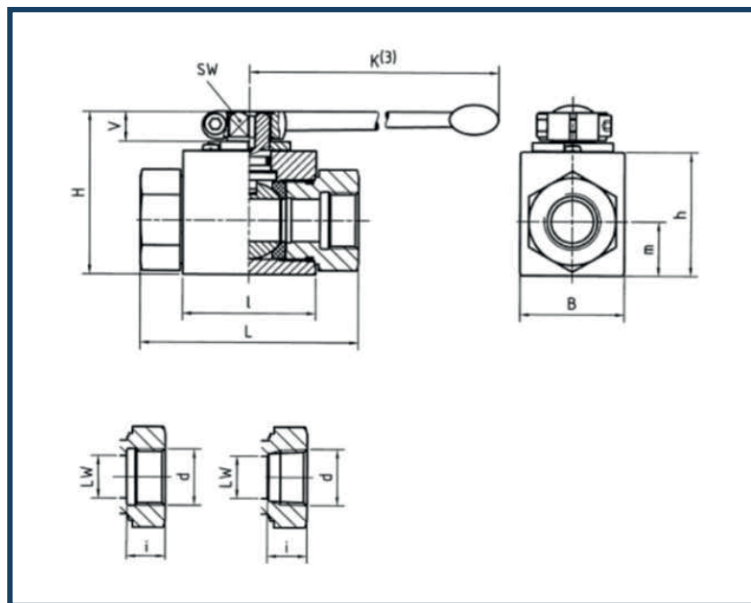

9662

HYDRAULIQUE > VANNES



**VANNE A BOULE HP 500b
1/4 BSP**

Poids net : 0.300 kg

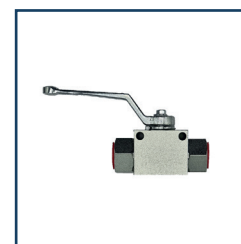
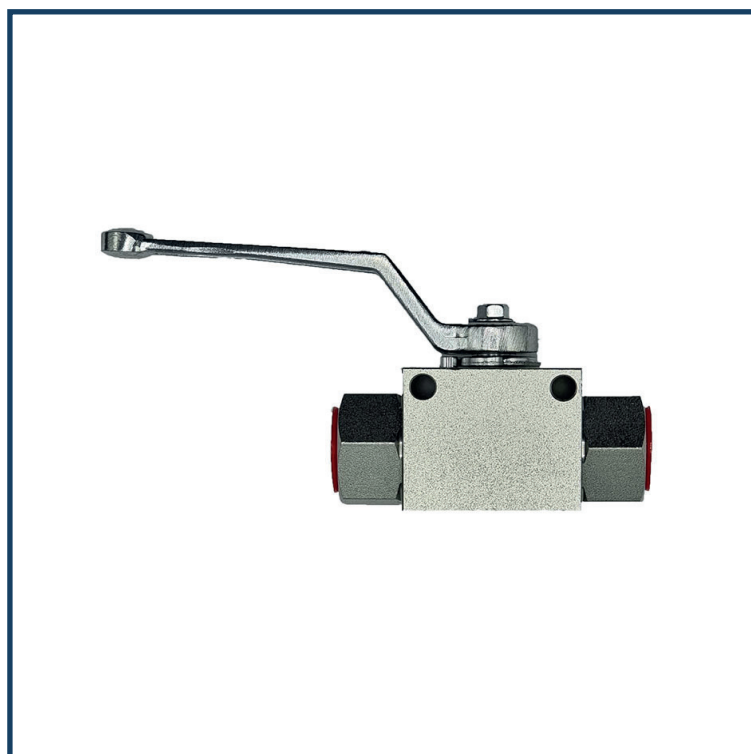

Toutes informations contenues dans cette fiche ont pour but d'aider et d'informer l'utilisateur. Il appartient donc à l'utilisateur de s'assurer au préalable que le produit convient à l'emploi qu'il souhaite en faire. FAB'HYDRO ne pouvant en aucun cas être tenue responsable de l'utilisation du produit.



9662

Référence	DN mm	PN bar	LW mm	L mm	I mm	B mm	H mm	h mm	m mm	V mm	SW mm	K mm	i mm	d BSP
9662	6	500	6	69	40	26	47	33	13,5	11	9	115	14	1/4"
9665	10	500	10	72	43	32	52	38	17,5	11	9	115	14	3/8"
9666	13	500	13	83	48	35	54	40	19	11	9	115	16,3	1/2"
9668	20	315	20	95	62	49	75	57	24,5	14	14	200	18	3/4"
9669	25	315	25	113	66	58	83	65	29,5	14	14	200	20	1"
9670	25/32	315	25	120	66	58	83	65	29,5	14	14	200	22	1 1/4"
9671	25	350	25	124	66,5	55	-	-	-	-	-	-	-	1 1/2"

Infos supplémentaires

Matériel : Fe/Zn